

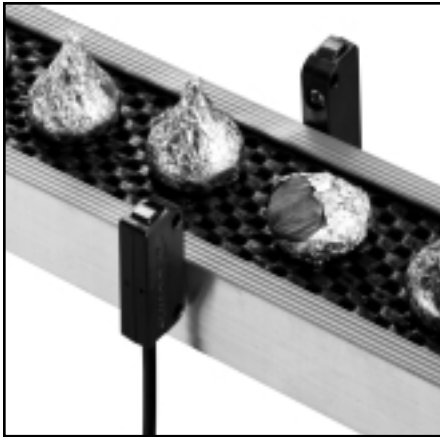

Q14 Series

Miniature self-contained dc photoelectric sensors



Q14 Series Features

- Self-contained dc sensors in miniature right-angle housings
- IP54; NEMA 4 construction; hermetically-sealed optics
- 1.8 m (70") opposed range
- Choose models for light operate or dark operate; choose either NPN (sinking) or PNP (sourcing) output models
- Choice of integral cable or quick-disconnect connector
- Mounting bracket is included



Infrared, 880 nm



Q14 Series Opposed-Mode Emitter (E) and Receiver (R)

Models	Range	Cable*	Supply Voltage	NPN/ PNP	L.O./ D.O.	Excess Gain	Beam Pattern
Q146E Q146EQ	1.8 m (70")	2 m (6.5') 3-Pin Pico-style Pigtail QD	10-30V dc	—	—		
Q14AN6R Q14AN6RQ		2 m (6.5') 3-Pin Pico-style Pigtail QD		NPN	L.O.		
Q14RN6R Q14RN6RQ		2 m (6.5') 3-Pin Pico-style Pigtail QD		NPN	D.O.		
Q14AP6R Q14AP6RQ		2 m (6.5') 3-Pin Pico-style Pigtail QD		PNP	L.O.		
Q14RP6R Q14RP6RQ		2 m (6.5') 3-Pin Pico-style Pigtail QD		PNP	D.O.		

*A model with a QD connector requires an optional mating cable (see page 4).



WARNING . . . Not To Be Used for Personnel Protection

Never use these products as sensing devices for personnel protection. Doing so could lead to serious injury or death.

These sensors do NOT include the self-checking redundant circuitry necessary to allow their use in personnel safety applications. A sensor failure or malfunction can cause either an energized or de-energized sensor output condition. Consult your current Banner Safety Products catalog for safety products which meet OSHA, ANSI and IEC standards for personnel protection.

Q14 Series

Q14 Series Specifications

Supply Voltage and Current	10 to 30V dc (10% maximum ripple); Emitter: 15 mA; Receiver: 15 mA (exclusive of load)
Supply Protection Circuitry	Protected against reverse polarity
Output Configuration	SPST solid-state dc switch; Choose NPN (current sinking) or PNP (current sourcing) models Choose light operate (N.O.) or dark operate (N.C.) models
Output Rating	150 mA maximum Off-state leakage current: <10 microamps at 30V dc; On-state saturation voltage: <0.5V at 10 mA dc; <1.0V at 150 mA dc
Output Protection Circuitry	Protected against false pulse on power-up and continuous overload or short circuit of outputs Overload trip point ≥220 mA, typical, at 20°C
Output Response Time	8 ms ON, 4 ms OFF
Repeatability	1.0 ms
Indicators	Receivers have two LEDs: Green and Yellow Green glowing steadily = power to sensor is ON Green flashing = output is overloaded Yellow glowing steadily = light is sensed Yellow flashing = marginal excess gain (1-1.5x) in light condition Emitter: One GREEN LED indicates power to sensor is ON
Construction	Housings are black ABS; Rated UL 94V0 Lenses are hermetically-sealed glass Stainless steel M3 mounting hardware is included; stainless steel mounting bracket is included
Environmental Rating	IP54; NEMA 4
Connections	2 m (6.5') or 9 m (30') attached cable, or 3-pin Pico-style pigtail quick-disconnect fitting. QD cables are ordered separately.
Operating Conditions	Temperature: -20° to +55°C (-5° to +131°F) Maximum Relative Humidity: 90% at 50°C (non-condensing)
Certifications	

Q14 Series Hookups

**Emitters
Cabled Hookup**

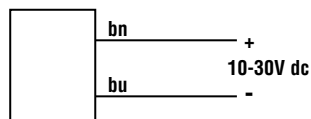

**Receivers with NPN Outputs
Cabled Hookup**

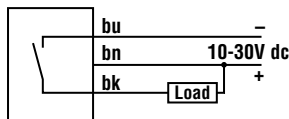

**Receivers with PNP Outputs
Cabled Hookup**

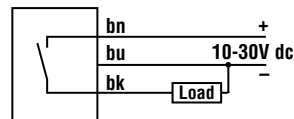

**Emitters
Quick-Disconnect Hookup**

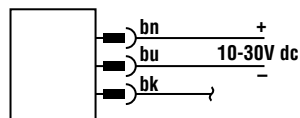

**Receivers with NPN Outputs
Quick-Disconnect Hookup**

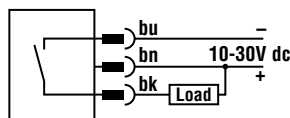

**Receivers with PNP Outputs
Quick-Disconnect Hookup**

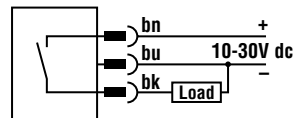

Q14 Series Dimensions

Cabled Models

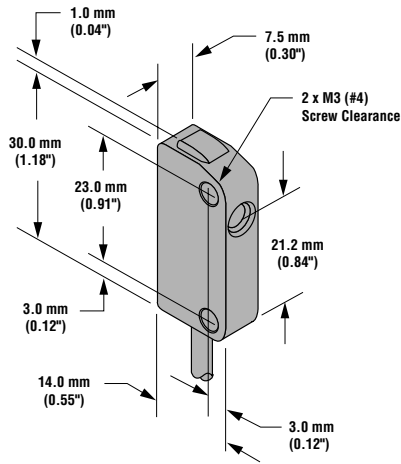

Quick-Disconnect Models

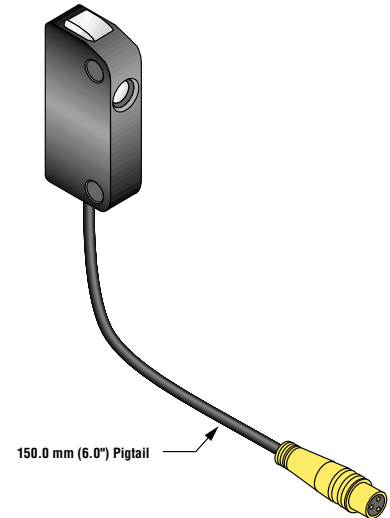

Mounting Bracket (included)

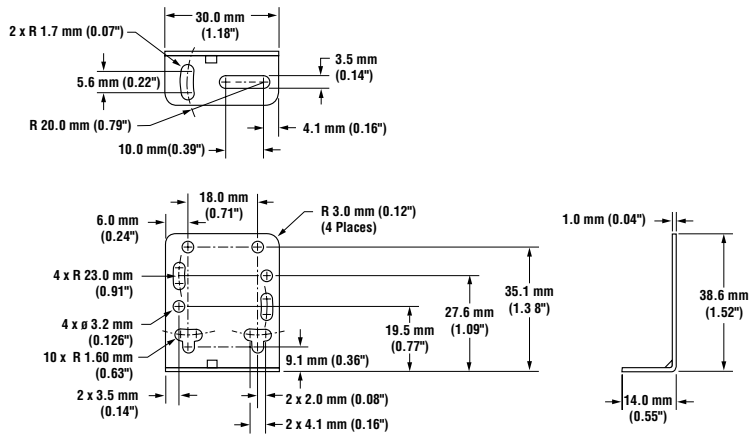

Mounting Orientation

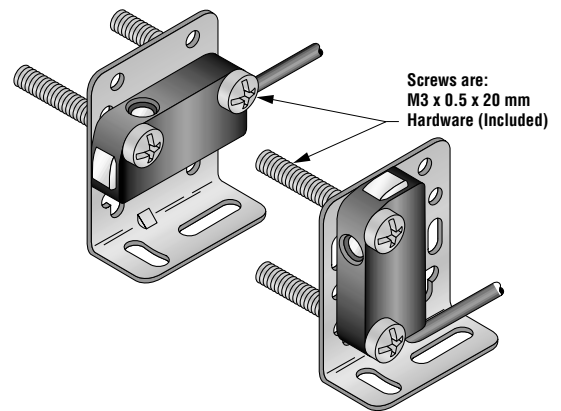

Q14 Series

Accessories

Quick-Disconnect (QD) Cables

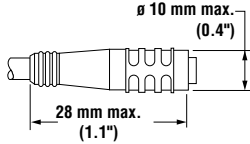
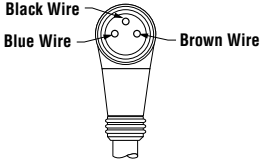
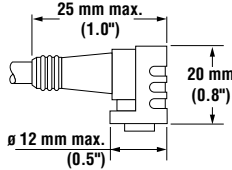
Style	Model	Length	For use with	Dimensions	Pinout
3-pin Pico Style straight	PKG3-2	2 m (6.5')	All Q14 sensors with quick-disconnect fitting		
3-pin Pico Style right-angle	PKW3-2	2 m (6.5')			



Banner Engineering Corp Limited Warranty

Banner Engineering Corp. warrants its products to be free from defects in material and workmanship for one year following the date of shipment. Banner Engineering Corp. will repair or replace, free of charge, any product of its manufacture which, at the time it is returned to the factory, is found to have been defective during the warranty period. This warranty does not cover damage or liability for misuse, abuse, or the improper application or installation of the Banner product. THIS LIMITED WARRANTY IS EXCLUSIVE AND IN LIEU OF ALL OTHER WARRANTIES WHETHER EXPRESS OR IMPLIED (INCLUDING, WITHOUT LIMITATION, ANY WARRANTY OF MERCHANTABILITY OR FITNESS FOR A PARTICULAR PURPOSE), AND WHETHER ARISING UNDER COURSE OF PERFORMANCE, COURSE OF DEALING OR TRADE USAGE.

This Warranty is exclusive and limited to repair or, at the discretion of Banner Engineering Corp., replacement. IN NO EVENT SHALL BANNER ENGINEERING CORP. BE LIABLE TO BUYER OR ANY OTHER PERSON OR ENTITY FOR ANY EXTRA COSTS, EXPENSES, LOSSES, LOSS OF PROFITS, OR ANY INCIDENTAL, CONSEQUENTIAL OR SPECIAL DAMAGES RESULTING FROM ANY PRODUCT DEFECT OR FROM THE USE OR INABILITY TO USE THE PRODUCT, WHETHER ARISING IN CONTRACT OR WARRANTY, STATUTE, TORT, STRICT LIABILITY, NEGLIGENCE, OR OTHERWISE.

Banner Engineering Corp. reserves the right to change, modify or improve the design of the product without assuming any obligations or liabilities relating to any product previously manufactured by Banner Engineering Corp.